**FORM A****FORM B****FORM C****FORM D**

SPØRG OM PRIS

Detail Z

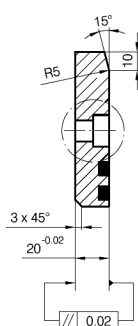
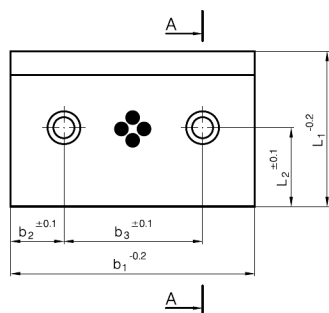
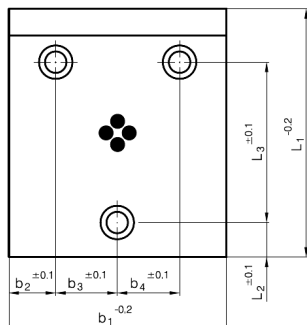
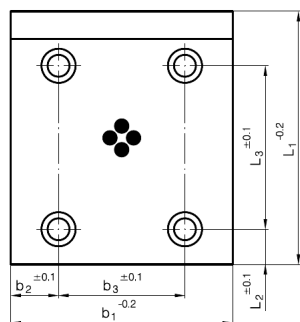
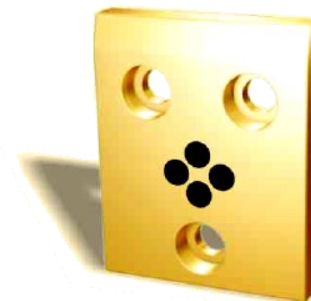
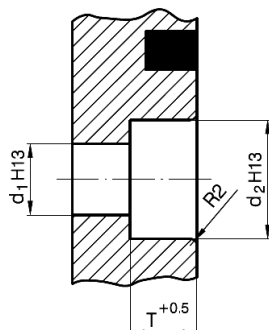

VDI 3357

Artikel nummer	Materiale
1280	GK-CuZn25A15 med smøremiddel
1280 .S	Wr. N 1.7131 - Hærdet uden smøremidde

Forboring	T	d1	d2
M8 x 25	9	9	15
M12 x 25	13	13,5	20

Bestillingsnr.: Artikel nr. + b1 x L1

b2	b3	b4	L2	L3	Form		b1	L1	Pris						
25	-	-	25	30	A	M8 x 25	50	80	SPØRG OM PRIS						
				50		M12 x 25		100							
				75				125							
				110				160							
				150				200							
30	-	-	25	-	A	M8 x 25	80	50							
40				-				-		25	30	80			
											50	100			
											75	125			
											110	160			
											150	200			
40				-				-		40	170	250			
											235	315			
											25	50	-	25	-
40				-				25		A					75
	110	125													
	150	180													
	170	200													
235	250														
25	75	-	-	25	B	M12 x 25	125	50							
				40				-	80						
				37,5				37,5	25	C	50	100			
	75	125													
	110	160													
	150	200													
	170	250													
	235	315													
	110	-	-	40	-		B	160	50						
					55				55	25	C	80			
												50	100		
	75	125													
	110	160													
	110	-	-	40	170		D		200						
					235				-	25	C	250			
315															

FORM A

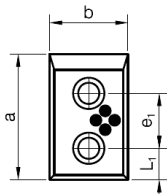

FORM B

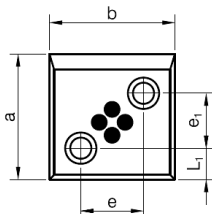

FORM C

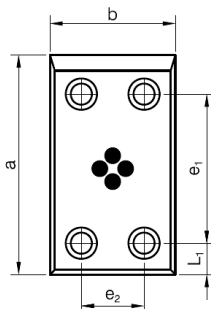

FORM D

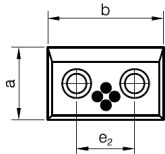

FORM E

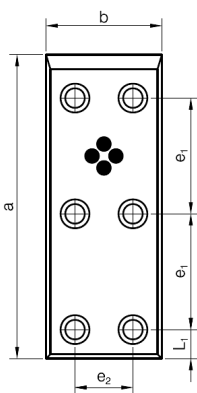

FORM F

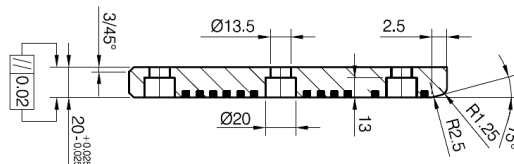
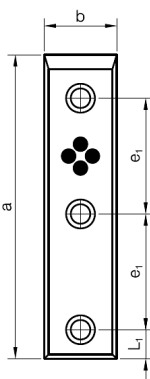

Bestillingsnr.: 1280.1 - b x a

L1	e1	e2	b	a	Form	Pris
20	35	40	50	80	A	SPØRG OM PRIS
	55			100		
	80			125		
	115			160		
	155			200		
25	100	250	F			
20	0	40	80	50	D	
	35			80	B	
	55			100		
	80			125		
	115			160	C	
	155			200	E	
	100			250		
132	315					
25	0	60	100	50	D	
20	35			80	B	
	55			100		
	80			125		
	115			160	C	
	155			200		

L1	e1	e2	b	a	Form	Pris
20	100	60	100	250	E	SPØRG OM PRIS
	132			315		
25	0	85	125	50	D	
20	35			80	C	
	55			100		
	80			125		
	115			160		
	155			200		
100	250	E				
132	315					
25	0	120	160	50	D	
20	35			80	C	
	55			100		
	80			125		
	115			160		
	155			200		
	100			250		
132	315					
115	160	160	200	160	C	
155	200					

FORM A

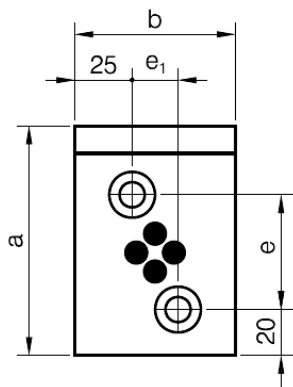

FORM C

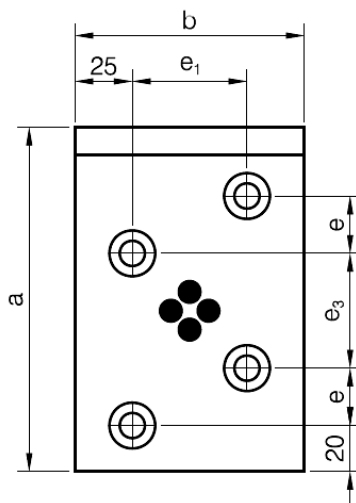

FORM B

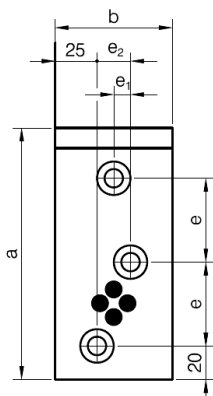

FORM D

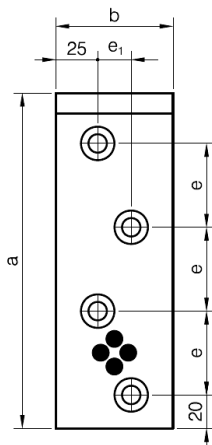

FORM E

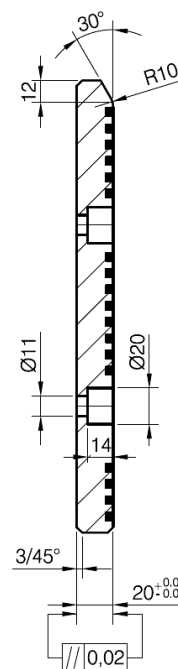
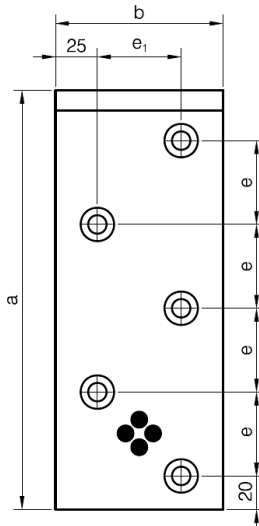

SPØRG OM PRIS

Bestillingsnr.: 1280.2 - b x a

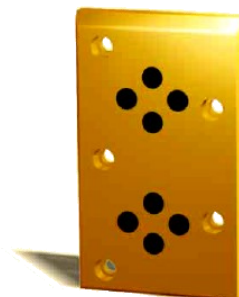
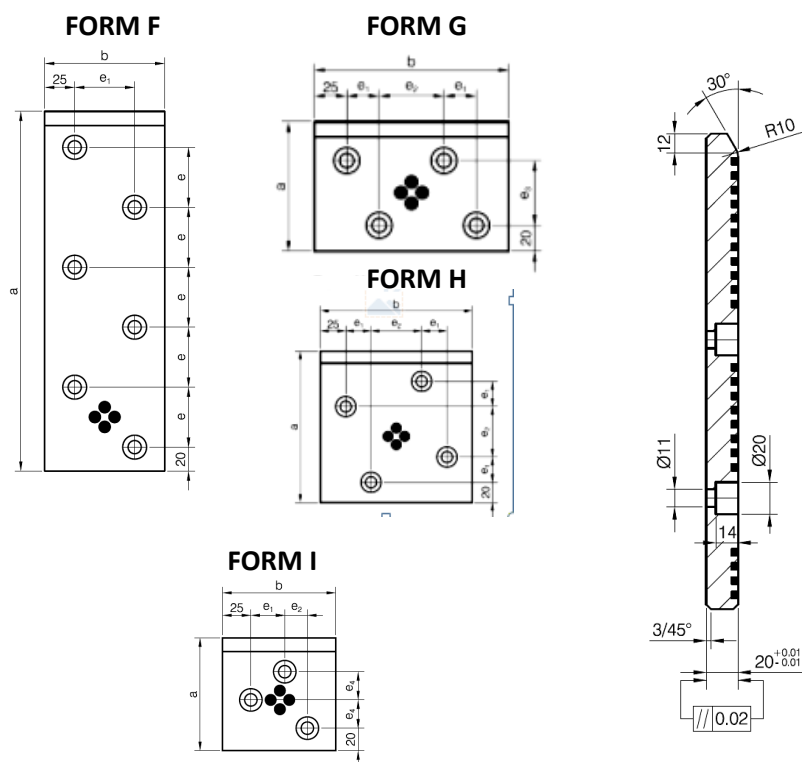

Bestillingsnr.: 1280.2 - b x a

e	e1	e2	e3	e4	b	a	Form	Pris
50	20	-	-	-	70	100	A	SPØRG OM PRIS
	10	20				150	B	
	20	-				200	D	
-	30	20	25	100	100	I		
25	50	-	50		150	C		
50		-	-		200	D		
		-	-		250	E		
-	25	50	50	150	300	F		
50	100	-	-		100	G		
					150	H		
					200	D		
-	50	50	50	200	250	E		
					300	F		
					100	G		

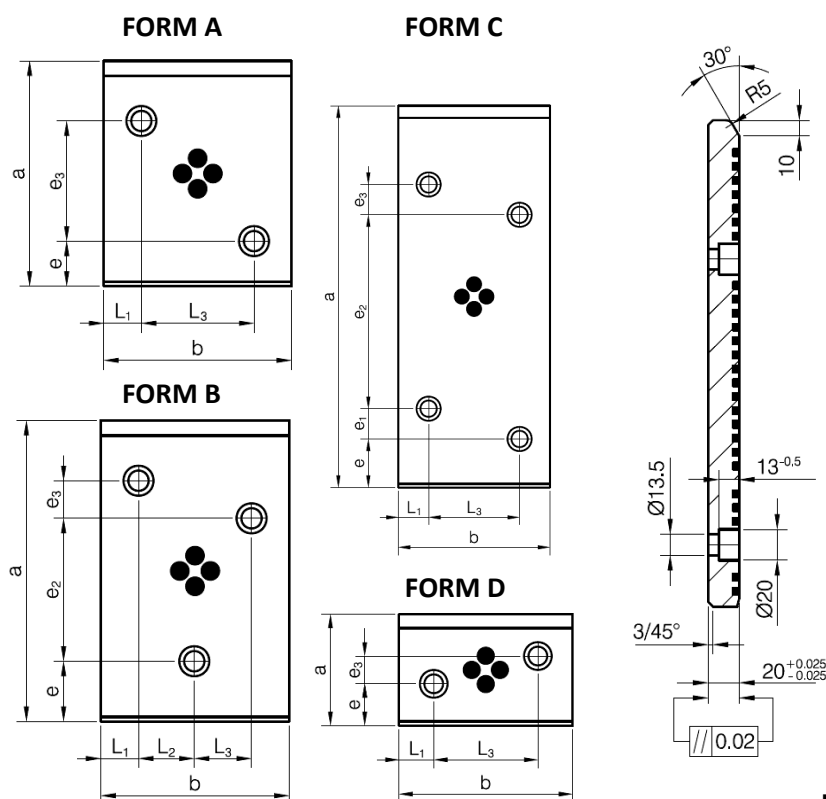

Bestillingsnr.: 1280.3 - b x a

L1	L2	L3	e	e1	e2	e3	b	a	Form	Pris
25	-	-	30	-	-	30	50	100	A	SPØRG OM PRIS
			40			80		150		
			40			120		200		
20	-	40	30	-	-	30	80	100		
			40			80		150		
			40			120		200		
22	-	56	14	-	-	25	100	315	B	
			30			13		50	D	
			40			20		80	A	
25	-	75	30	-	-	3	125	100	A	
			40			80		150	B	
			40			95		200	D	
30	-	100	30	-	-	25	160	250	A	
			40			80		315	B	
			40			95		250	C	
30	-	100	30	25	210	25	160	315	A	
			40			30		100	B	
			40			80		150	C	
30	50	50	30	-	-	30	160	200	A	
			40			80		250	B	
			40			95		315	C	
30	-	100	30	25	210	25	160	250	A	
			40			30		315	B	
			40			80		315	C	

FORM A

FORM B

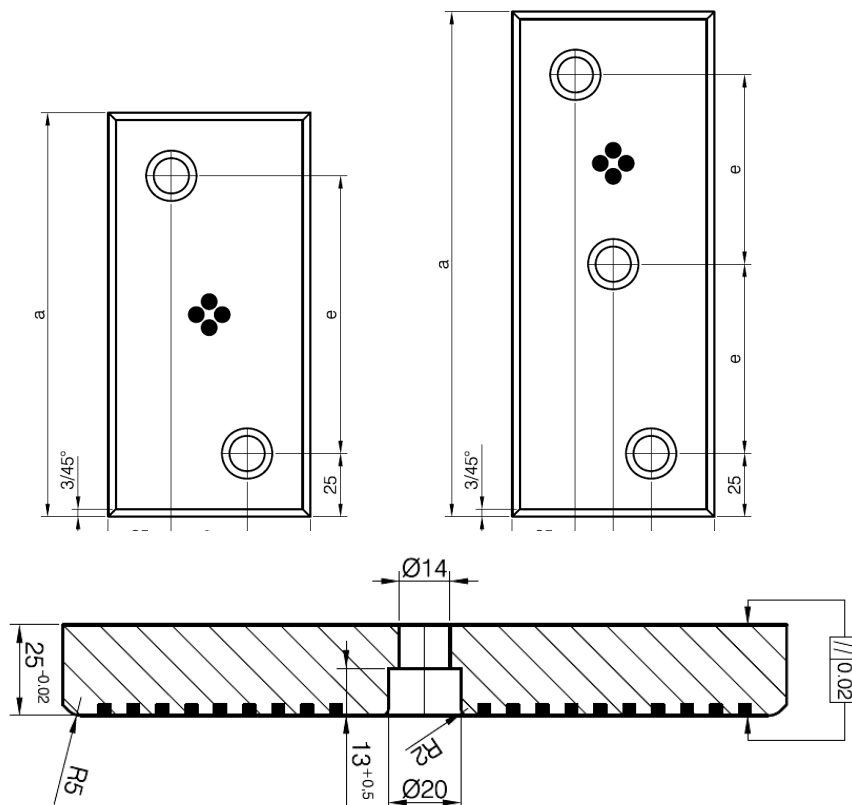

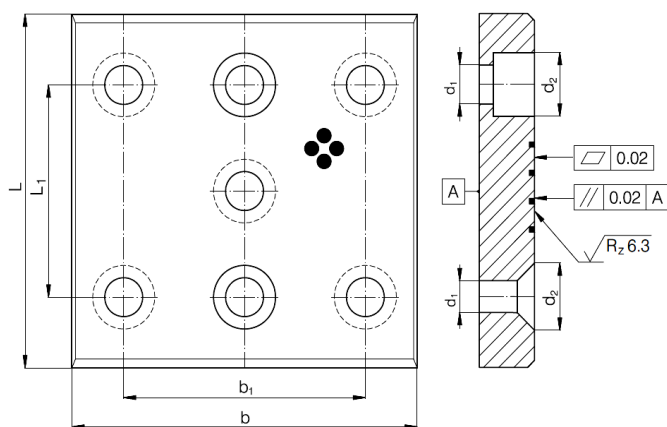

Bestillingsnr.: 1280.4 - b x a

e1	e	b	a	Form	Pris
30	50	80	100	A	SPØRG OM PRIS
	75		125		
	110		160	B	
	150		200		
50	75	100	125	A	
	110		160	B	
	150		200		
75	75	125	125	A	



Bestillingsnr.: 1280.5 - b x L x s

b	L	s	b1	L1		d1	d2	t		Pris
125	100	20	85	60	•••••	13,5	20,0	13	DIN 912 M12 X 25	SPØRG OM PRIS
	160			•••••						
	250			•••••						
100	100	16	60	60	•••••	11,0	18,0	11	DIN 912 M10 X 20	
	160			•••••						
	250			•••••						
80	100	12	40	60	•••••	9,0	15,0	9	DIN 912 M8 X 20	
	160			•••••						
	250			•••••						
80	100	20	40	60	•••••	13,5	20,0	13	DIN 912 M12 X 25	
	160			•••••						
	250			•••••						
60	100	16	30	60	•••••	11,0	18,0	11	DIN 912 M10 X 20	
	160			•••••						
	160			•••••						
	200			•••••						
50	100	20	20	60	•••••	13,5	20,0	13	DIN 912 M12 X 25	
	160			•••••						
	250			•••••						
40	100	8	-	60	•••••	9,0	16,4	5	 DIN 7991 M8 X 15	
	160			•••••						
	250			•••••						
40	100	12	-	60	•••••	11,0	18,0	11	DIN 912 M8 X 20	
	160			•••••						
	250			•••••						
40	100	16	-	60	•••••	11,0	18,0	11	DIN 912 M10 X 20	
	160			•••••						
	250			•••••						
30	100	12	-	60	•••••	9,0	15,0	9	DIN 912 M8 X 20	
	160			•••••						
	250			•••••						

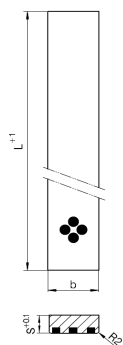

Bestillingsnr.: 1281 - b x L x s

b	L	s	Pris
20	305	4	SPØRG OM PRIS
	605	10	
	1005	12	
	1005	12	
25	305	5	
	500		
	605		
	1005		
30	500	6	
	605		
	1005		
	1005		
	500	8	
	605		
	1005		
	1005		
35	605	10	
	1005		
	1005		
40	500	8	
	605		
	1005		
	1005		
	500	10	
	605		
	1005		
	1005		
	500		12
	605		
1005			
1005			
50	500	16	
	605		
	1005		
	1005		
	500		
50	1005	8	
	500		
	605		
	1005		
50	500	10	
	605		
	1005		
	500		
50	1005	12	
	500		
	605		
	1005		

b	L	s	Pris	
50	605	12	SPØRG OM PRIS	
	1005			
	605	20		
	1005			
60	605	8		
	1005			
	605			10
	1005			
	605	12		
	1005			
	500			16
	605			
1005				
1005				
75	605	12		
	1005			
80	500	12		
	605			
	1005			
	1005			
	500	16		
	605			
	1005			
	1005			
100	500	20		
	1005			
	1005	10		
	1005			
	605		16	
	500			
1005				
125	605	20		
	1005			
160	1005	20		

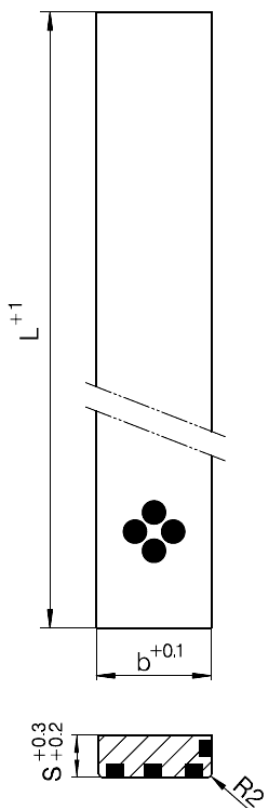

Bestillingsnr.: 1281.1 - b x L x s

b	L	s	Pris
25	305	5	SPØRG OM PRIS
30		6	
35	1005	10	
40		8	
		12	
50		10	
		20	
60		16	
		20	
80		12	
	20		
100		20	

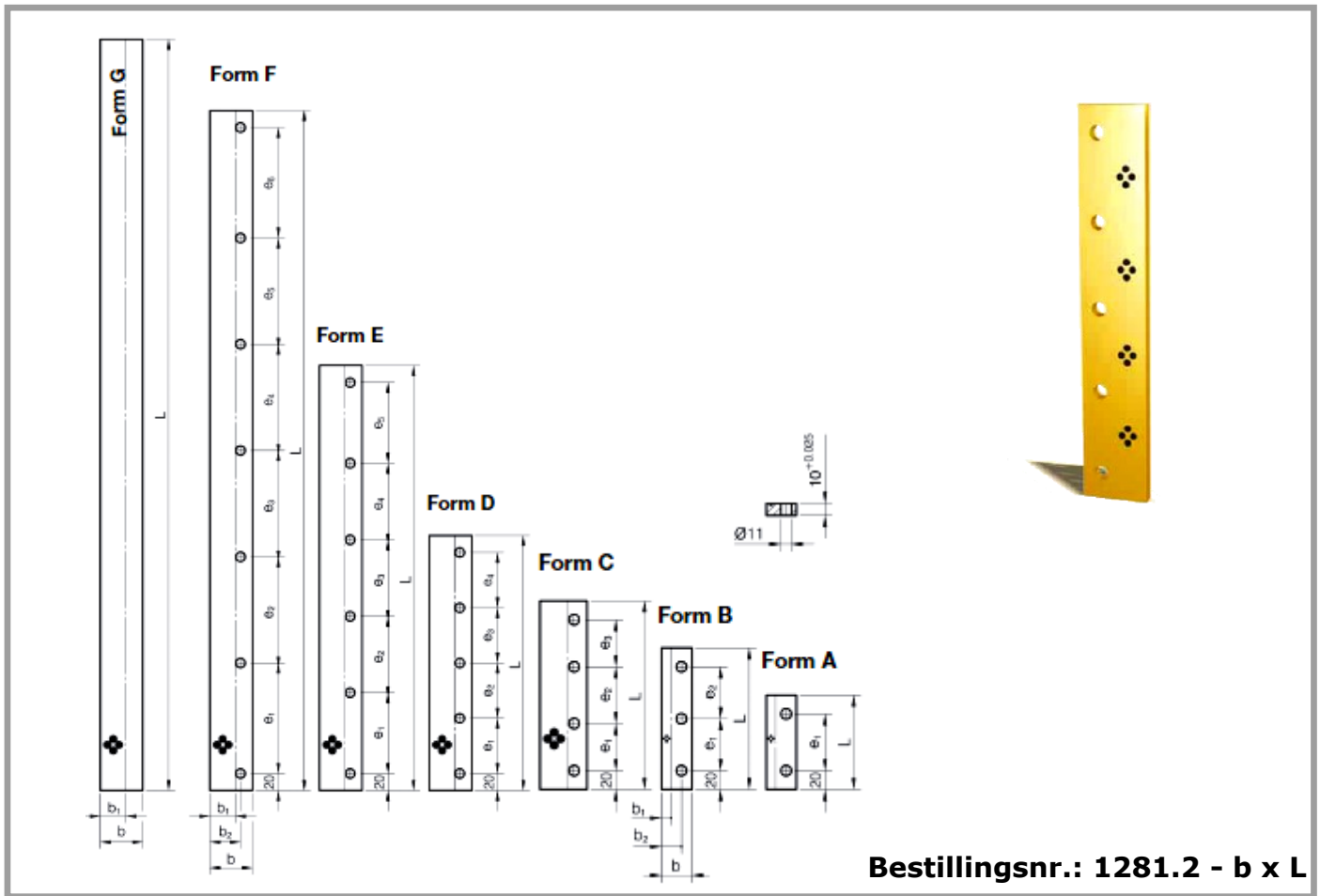

Bestillingsnr.: 1281.2 - b x L

e1	e2	e3	e4	e5	e6	b1	b2	Form	b	L	Pris
60	55	55	65	95	130	10	21	A	32	100	SPØRG OM PRIS
55								B		150	
60	60					C	160				
55	50	70	D	200							
70	70	70	D	250							
65	65	65	D	300							
80	75	75	D	350							
90	90	90	90	95	30	36	E	50	400		
95							F		500		
115	110	110	110	115			G		600		
130	125	125	125	125			G		800		
										605	
										1005	

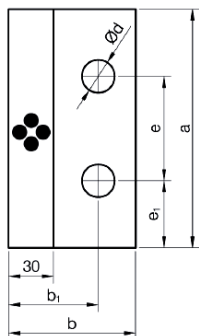

FORM A

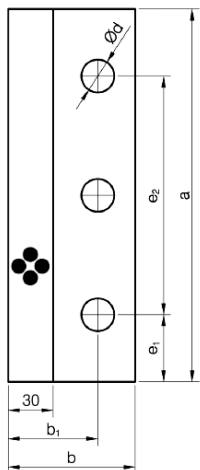

FORM B

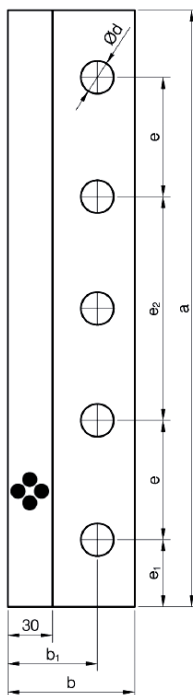

FORM C



Bestillingsnr.: 1281.3 - b x a x s

b1	e	e1	e2	d	b	a	s	Form	Pris
60	70	45	-	22	85	160	30	A	SPØRG OM PRIS
	110		-			B			
	-		160			B			
	-		210			B			
	-		260			B			
	80		150			C			
-	-	-	-	-	1005	-	-		
75	70	45	-	18	125	160	25	A	
	110		-			B			
	-		160			B			
	80		150			C			
	-	-	-	-		-	1005	-	-
	70	45	-	22		160	30	A	
	110		-			B			
	-		160			B			
	-		210			B			
	-		260			B			
	80		150			C			
	-	50	190	-		450	C		
	-	-	240	-		500	-		
	-	-	-	-		-	1005	-	-

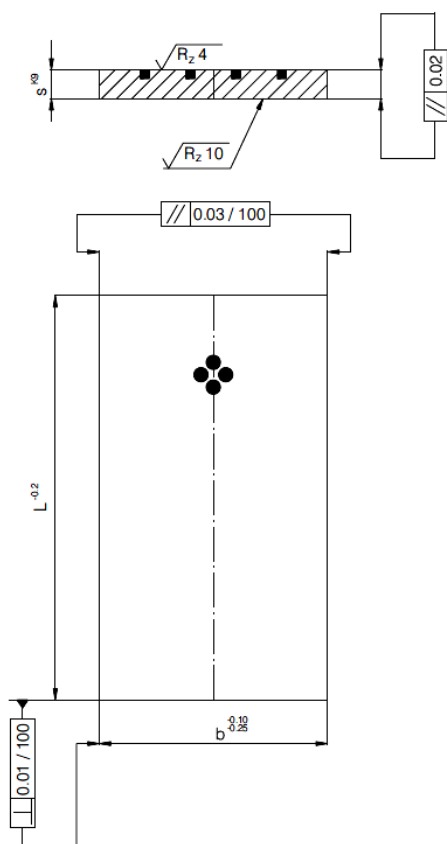

Bestillingsnr.: 1281.4 ISO b x s x L

b	s	L	Pris
25	5	50	SPØRG OM PRIS
		71	
		90	
40		50	
		71	
		90	
40	6	80	
		100	
		125	
		160	
		200	
		63	
100			
125			
160			

FORM A

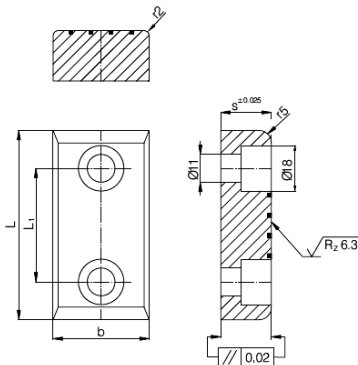

FORM B

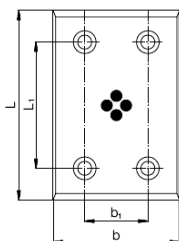

FORM C

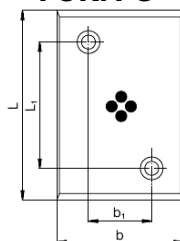

Bestillingsnr.: 1281.5 - b x L x Form

b x L x s	b1	L1	Form	Pris
28x75x20		45	A	SPØRG OM PRIS
28x100x20		50		
28x125x20		75		
28x150x20		100		
38x75x20		45		
38x100x20		50		
38x125x20		75		
38x150x20		100		
38x200x20		150		
48x75x20		45		
48x100x20		50		
48x125x20		75		
48x150x20		100		
48x200x20		150		
58x75x20		45		
58x100x20		50		
58x150x20		100		
75x75x20		25		
75x100x20		50		
75x125x20		75		
75x150x20		100		

b x L x s	b1	L1	Form	Pris	
75x200x20		150	A	SPØRG OM PRIS	
75x100x20	25	50	C		
100x100x20		5	B		SPØRG OM PRIS
100x125x20		75			
100x150x20		100			
100x200x20		150			
100x250x20		200			
100x300x20		200			
125x125x20	50	75			
125x150x20		100			
125x200x20		150			
125x250x20		200			
125x300x20		250			
125x350x20		200			
150x150x20		100			
150x299x20	100	150			
150x250x20		200			
150x300x20		250			
200x200x20		150			
200x250x20	150	200			
200x300x200		250			

FORM D

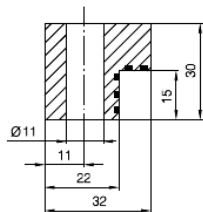

FORM H

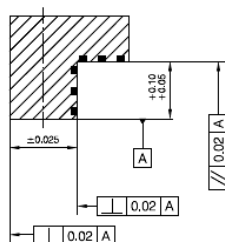
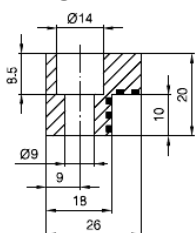

FORM F

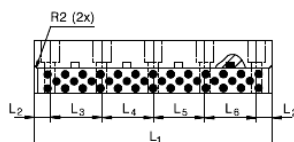
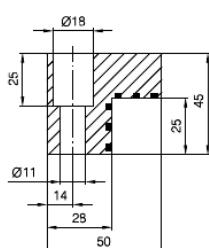

Bestillingsnr.: 1282 - Form x L1

L2	L3	L4	L5	L6		Form	L1	Pris	
20	60	-	-	-	2 X M8	H	100	SPØRG OM PRIS	
	55	55	-	-			3 X M8		150
		50	55	-			4 X M8		200
	60	-	-	-			2 X M10		D
	55	55	-	-	3 X M10	150			
		50	55	-	4 X M10	200			
	70	70	70	-		200			
	55	50	55	-	5 X M10	F	250		
	70	70	70	-			250		
	65	65	65	65			300		
80	75	75	75	80			350		

FORM A

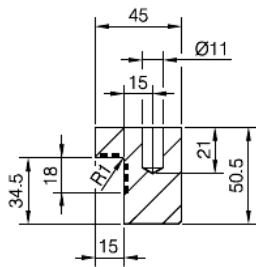

FORM B

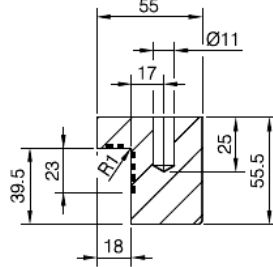

FORM C

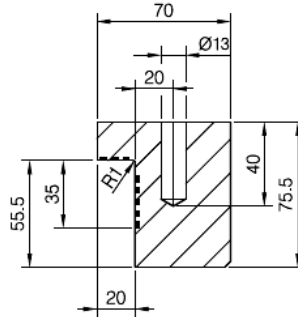

FORM D

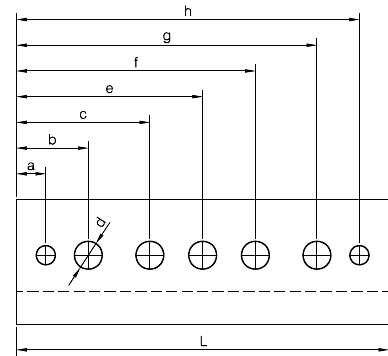
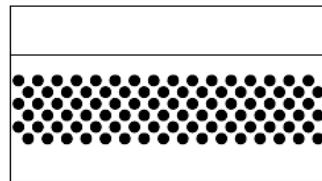
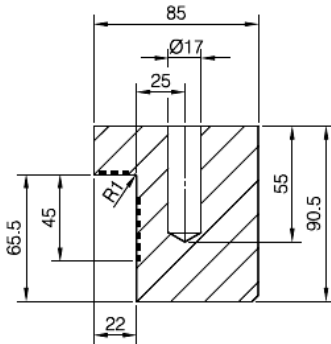

Bestillingsnr.: 1282.1 - Form x L1

a	b	c	e	f	g	h	d	Form	L	Pris				
10,0	27,5	-	-	-	72,5	90,0	13	A	100	SPØRG OM PRIS				
-					97,5	-			125					
10,0					132,5	150,0			160					
12,5	35,0				125	200		275	72,5		90,0	17	B	100
									132,5		150,0			160
									125,0		147,5			160
15,5	42,5	125	200	275			165,0		187,5		22		C	200
							215,0		237,5					250
							365,0		387,5					400
					117,5	145,0	160							
15,5	42,5				125	200	275	157,5	185,0			22	D	200
								207,5	235,0					250
		357,5	385,0	400										

FORM A

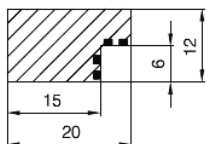

FORM B

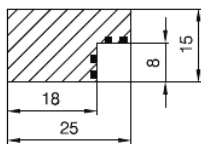

FORM C

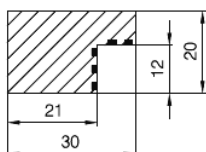

FORM E

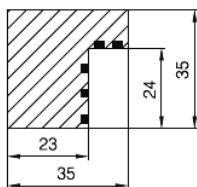

FORM G

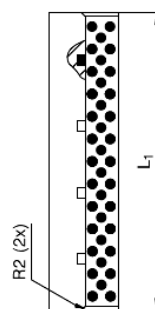
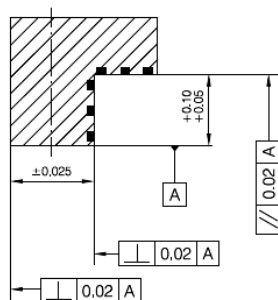
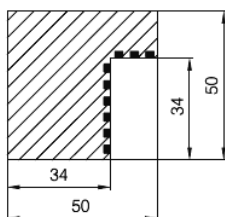

Bestillingsnr.: 1283 - Form x L1

Form	L1=500	L1=605	L1=1005	Pris
A	████████	████████	████████	SPØRG OM PRIS
B	████████	████████	████████	
C	████████	████████	████████	
D	████████	████████	████████	
E	████████	████████	████████	
G	████████	████████	████████	

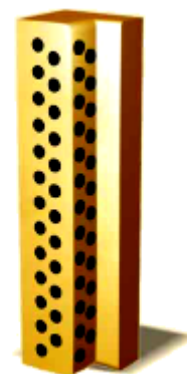
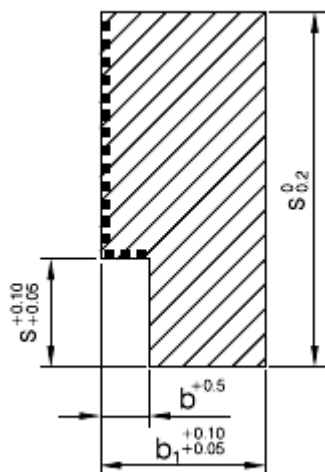

Bestillingsnr.: 1283.1 - b x s

L	b ₁	s ₁	b	s	Pris		
205	5	5	15	12	SPØRG OM PRIS		
605		8		7		20	17
				10			28
	12		40	27			
	22	36					
		26		46			
							66
				86			

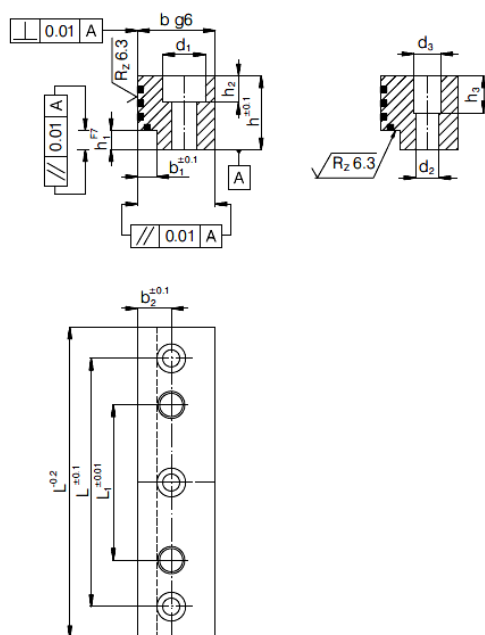

Bestillingsnr.: 1283.2 - b x L

b	L	h	b1	b2	L1	L2	h1	h2	h3	d	d1	d2	d3		Pris
16	50	11	5	9,5	34	14	4,0	5,7	-	5,5	10,0	5,0	-	2	SPRØG OM PRIS
	71				55	35								3	
	90				74	54								3	
20	80	19	5	12,0	64	40	5,0	6,8	9,5	6,6	11,0	6,0	7,0	2	
	100				84	60								3	
	125				109	85								3	
25	100	31	6	15,5	80	50	6,0	9,0	19,0	9,0	15,0	8,0	9,0	2	
	125				105	75								3	
	160				140	110								3	
30	125	49	7	18,0	95	55	8,0	11,0	34,0	11,0	18,0	10,0	12,0	2	
	160				130	90								3	
	200				170	130								3	

FORM A

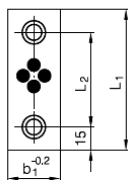

FORM C

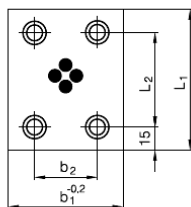

FORM B

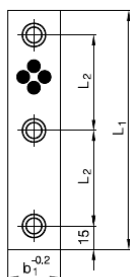

FORM D

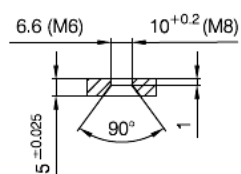
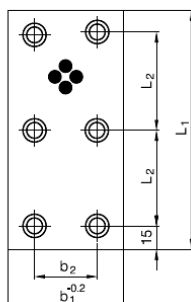

Bestillingsnr.: 1284 - b1 x L1 x Form

L2	Form		b2	b1	L1	Pris		
20	A	M6		18	50	SPØRG OM PRIS		
45					75			
70					100			
60	B			150				
20	A				28		50	
45							75	
70			100					
60	B		150					
20	A		M8				38	50
45								75
70				100				
60	B			150				
45	A			48		75		
70						100		
95					125			
60	B			150				
45	C			45	75	75		
70						100		
95		125						
60	D	150						
70	C	70	100		100			
95					125			
60				D	150			

FORM A

FORM B

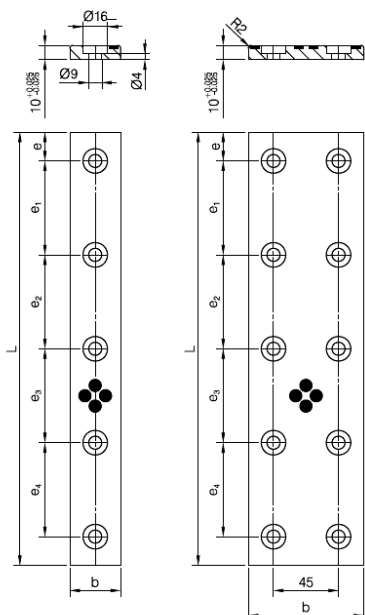

Bestillingsnr.: 1284.1 - b x L

e	e1	e2	e3	e4	b	L	Form	Pris
20	60	-	-	-	35	100	A	SPØRG OM PRIS
	55	55	-	-		150		
		50	55	-		200		
	70	70	70	-		250		
	65	65	65	65		300		
	80	75	75	80		350		
	60	-	-	-	50	100		
	55	55	-	-		150		
		50	55	-		200		
	70	70	70	-		250		
	65	65	65	65		300		
	80	75	75	80		350		
	110	-	-	-	75	150	B	
	80	80	-	-		200		
	105	105	-	-		250		
	85	90	85	-		300		
	120	120	120	-		400		
	115	115	115	115		500		

FORM B

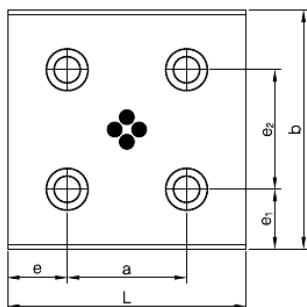

FORM A

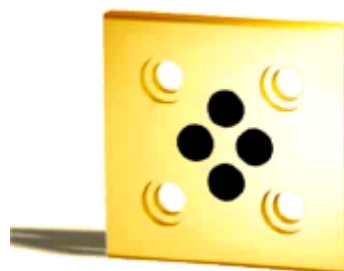
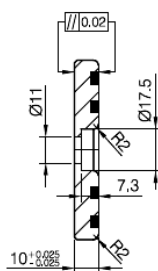
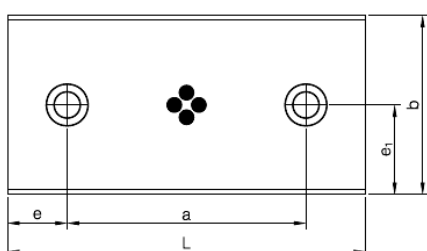

Bestillingsnr.: 1284.2 - b x L

e ₁	e ₂	a	e	b	L	Form	Pris				
14,0	-	45	15	28	75	A	SPØRG OM PRIS				
		50	25		100						
		75			38			125			
		100						150			
45		15		48				75			
50		25	100								
75			75		125						
100					150						
150				200							
37,5		50		45	15			100	75	B	
			50	25	100						
			75		125				125		
			100						150		150
			150								200
50			125					100			
75				150				125			
100	200				150						
150					250	200					
200						250	250				
100		150	150								
150			200	200							
200	250			250							
100				150	150						
150					200	200					
200		250				250					
25,0			100	100		150	150				
37,5	200			200	250		250				
25,0		250		250			300	300			

FORM A

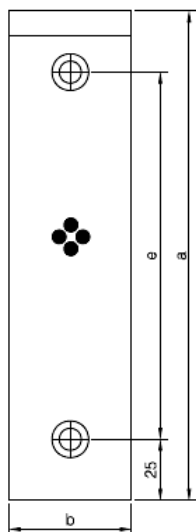

FORM C

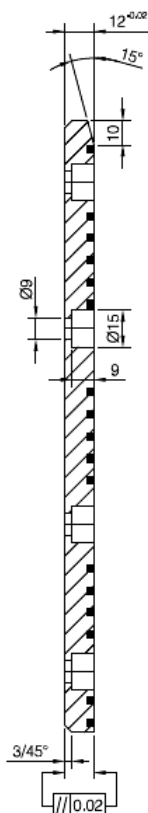
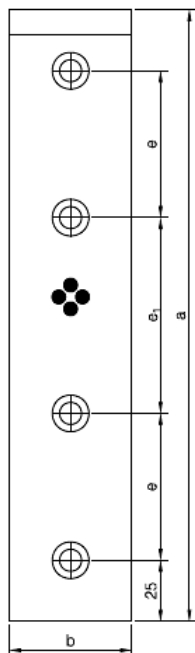

Bestillingsnr.: 1284.3 - b x a

e	e ₁	b	a	Form	Pris
110	-	25	160	A	SPØRG OM PRIS
150			200		
30		30	80		
50			100		
75			125		
110			160		
150			200		
30		40	80		
50			100		
75			125		
110			160		
150			200		
30	50	80			
50		100			
75		125			
110		160			
150		200			

e	e ₁	b	a	Form	Pris
150	-	50	200	A	SPØRG OM PRIS
60	80		250		
80	90		300		
100	100		350		
120	110		400		
30	-	60	80	A	
50			100		
75			125		
110			160		
150			200		
30		80	80		
50			100		
75			125		
110			160		
150			200		
70	60		250	C	

FORM A

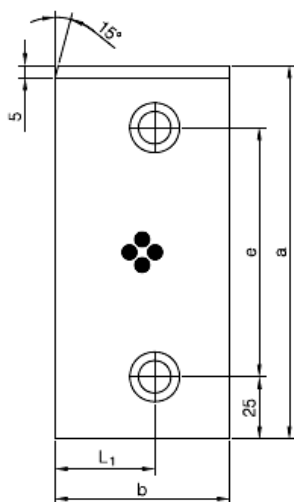
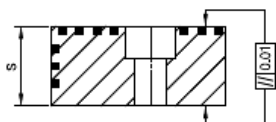

FORM B

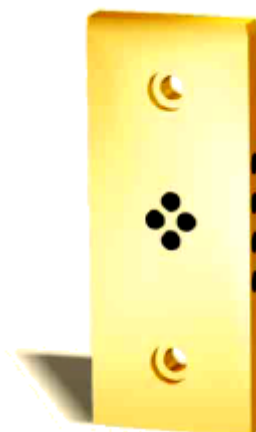
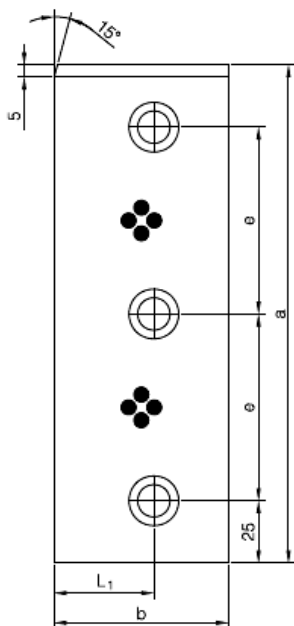

Bestillingsnr.: 1285 - b x a x s

L1	e	b	a	s	Form	Pris
30	75	60	125	30	A	SPØRG OM PRIS
	100		150		B	
	110		160		A	
	75		200			
	75		125	40	A	
	100		150		B	
	110		160			
	75		200			

FORM A

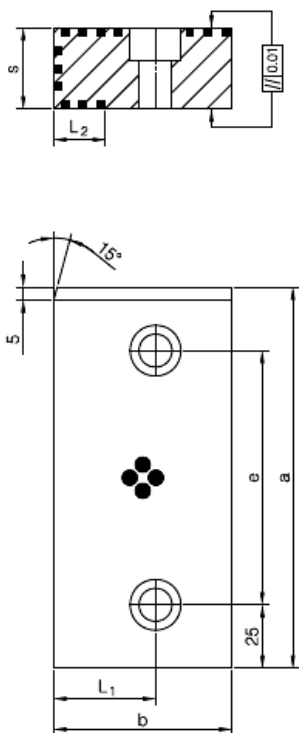

FORM B

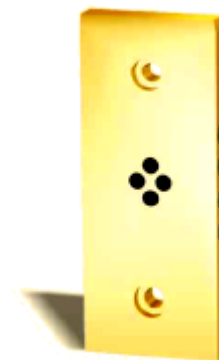
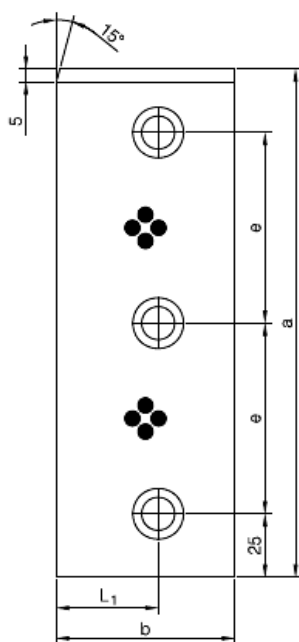

Bestillingsnr.: 1285.1 - b x a x s

L ₁	L ₂	e	b	a	s	Form	Pris
40	25	75	70	125	32	A	SPØRG OM PRIS
		100		150		A	
		75		200		B	
55	30	75	90	125	45	A	
		50		150		B	
		75		200		B	

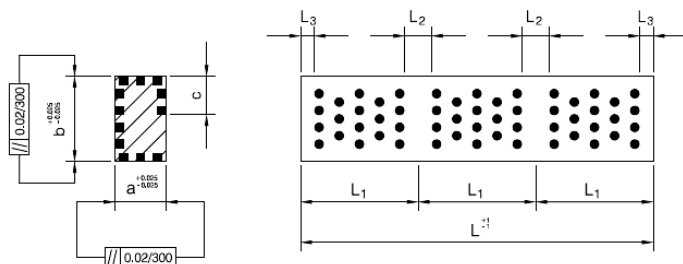

Bestillingsnr.: 1285.2 - b x a x L

c	L1	L2	b	a	L	Pris
6	25	6	15,3	10,30	75	SPØRG OM PRIS
					100	
					125	
					150	
					175	
					200	
					225	
					250	
					275	
300						
8	35	8	25,3	15,30	105	
					140	
					175	
					210	
					245	
					280	
					315	
					350	
					385	
420						
455						
490						
12	45	10	35,3	25,30	135	
					180	
					225	
					270	
					315	
					360	
					405	
					450	
					495	
16	55	12	45,3	35,30	165	
					220	
					275	
					330	
					385	
					440	
495						

FORM A

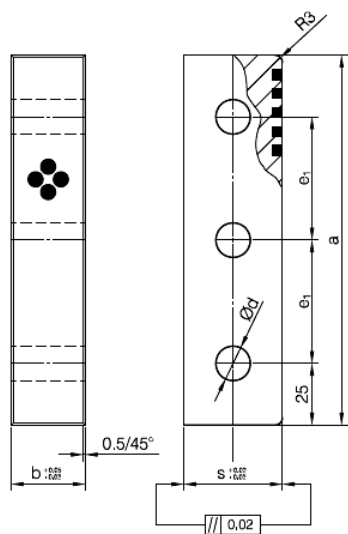

FORM B

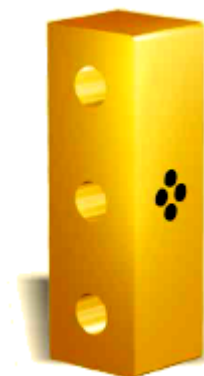
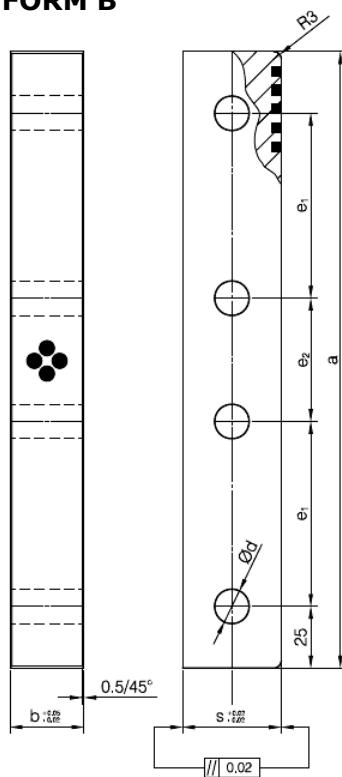

Bestillingsnr.: 1285.3 - b x a

e ₁	e ₂	d	b	a	s	Form	Pris
50	-	14	30	150	40	A	SPØRG OM PRIS
75	50			200		B	
50	-			250		A	
75	50	18	40	150	50	B	
50	-			200		A	
75	50			250		B	
50	-	18	45	150	50	A	
75	50			200		B	
50	-			250		A	
75	50	18	55	150	50	A	
50	-			200		B	
75	50			250		A	
50	-	18	60	150	50	A	
75	50			200		B	
50	-			250		A	
75	50	18	70	150	50	A	
50	-			200		B	
75	50			250		A	

FORM A

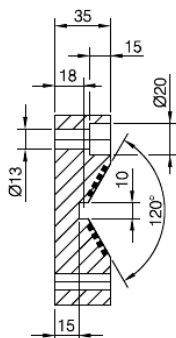
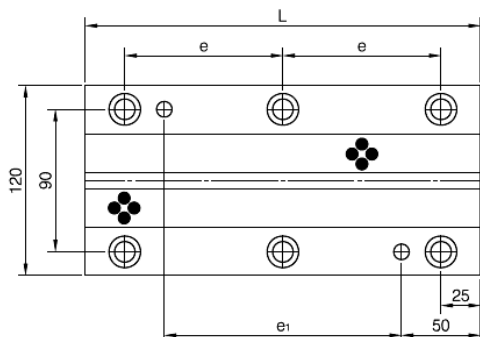

For FORM B

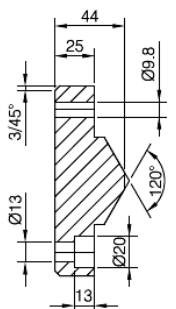
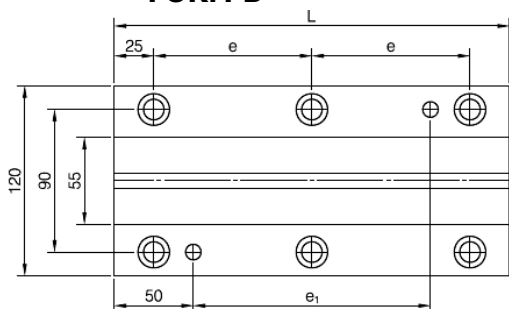

Bestillingsnr.: 1286 - L x Form

e	e ₁	L	Form		Pris
			A	B	
50	50	150	■	■	SPØRG OM PRIS
75	100	200	■	■	
100	150	250	■	■	
125	200	300	■	■	

FORM A

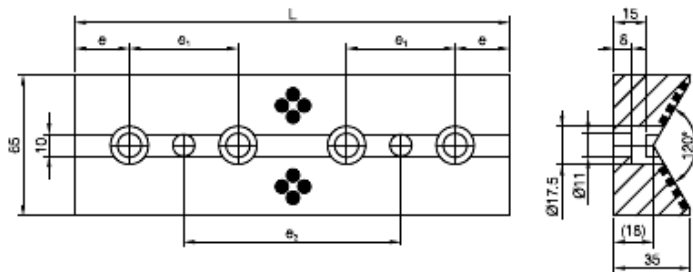

FORM B

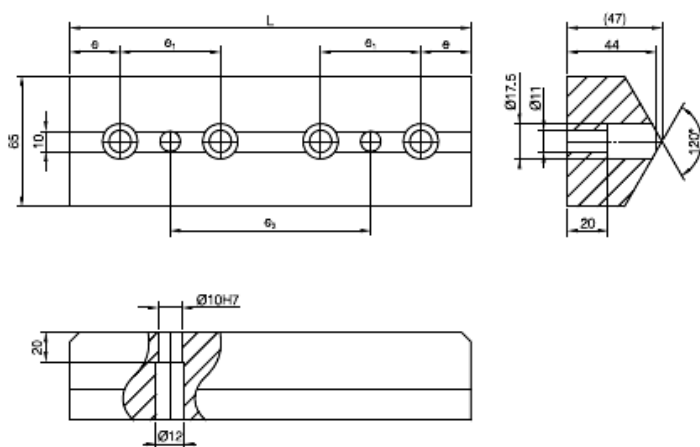

Bestillingsnr.: 1286.1 - L x Form

e	e ₁	e ₂	L	Form		Pris
				A	B	
20	60	20	100	<input type="checkbox"/>	<input type="checkbox"/>	SPØRG OM PRIS
25	50	50	150	<input type="checkbox"/>	<input type="checkbox"/>	
		100	200	<input type="checkbox"/>	<input type="checkbox"/>	
		150	250	<input type="checkbox"/>	<input type="checkbox"/>	
		200	300	<input type="checkbox"/>	<input type="checkbox"/>	

FORM A

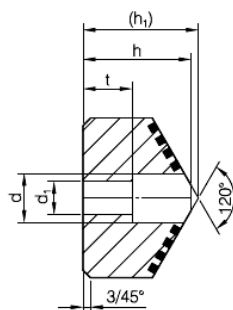
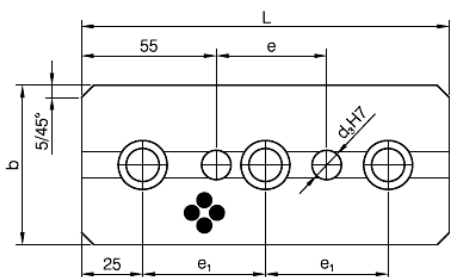

FORM B

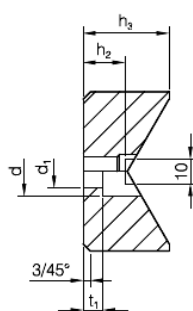
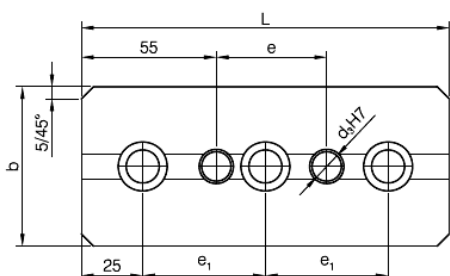

Bestillingsnr.: 1286.2 - L x Form

e	e ₁	h	h ₁	h ₂	h ₃	t	t ₁	d	d ₁	b	L	Form		Pris
												A	B	
45	50	44	47	15	35	20	8	20	13,5	65	150	<input type="checkbox"/>	<input type="checkbox"/>	SPØRG OM PRIS
95	75										200	<input type="checkbox"/>	<input type="checkbox"/>	
145	100										250	<input type="checkbox"/>	<input type="checkbox"/>	
195	125										300	<input type="checkbox"/>	<input type="checkbox"/>	
45	50	52	57	24	80	15	15	26	17,5	125	150	<input type="checkbox"/>	<input type="checkbox"/>	
95	75										200	<input type="checkbox"/>	<input type="checkbox"/>	
145	100										250	<input type="checkbox"/>	<input type="checkbox"/>	
195	125										300	<input type="checkbox"/>	<input type="checkbox"/>	

FORM A

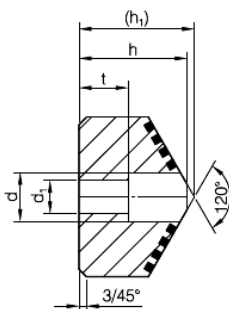
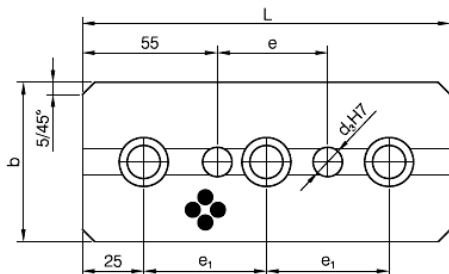

FORM B

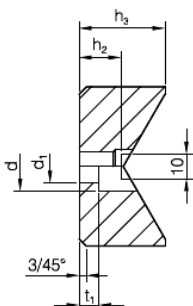
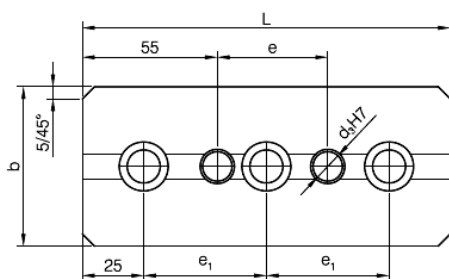

Bestillingsnr.: 1286.3 - L x Form

e	e ₁	h	h ₁	h ₂	h ₃	t	t ₁	d	d ₁	d ₃	b	L	Form		Pris
													A	B	
50	-	39	42	21	40	13	10	20	13,5	12	65	150	<input type="checkbox"/>	<input type="checkbox"/>	SPØRG OM PRIS
100												<input type="checkbox"/>	<input type="checkbox"/>		
150												<input type="checkbox"/>	<input type="checkbox"/>		
200												<input type="checkbox"/>	<input type="checkbox"/>		
50	100	52	57	27	60	15	15	26	17,5	16	125	150	<input type="checkbox"/>	<input type="checkbox"/>	
100												<input type="checkbox"/>	<input type="checkbox"/>		
150												<input type="checkbox"/>	<input type="checkbox"/>		
200												<input type="checkbox"/>	<input type="checkbox"/>		

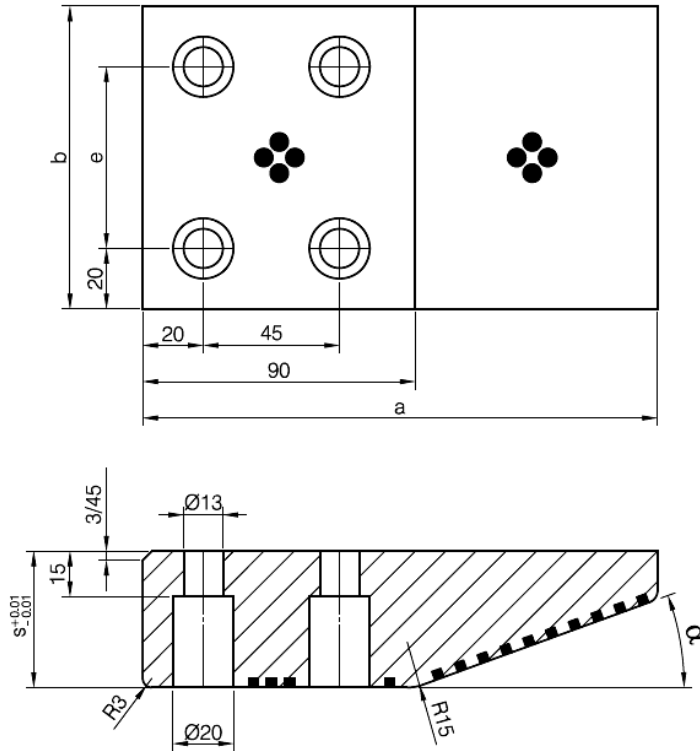

Bestillingsnr.: 1287 - L x Form

e	s	α	b	a	Pris
60	45	20	100	170	SPØRG OM PRIS
		30		150	
85	45	20	125	170	
		30		150	
	60	170			
110	45	20	150	170	
		30		150	
160	45	20	200	170	
		30		150	
	60	170			